

# Wirbelsäulenwächter Rückenstrecker

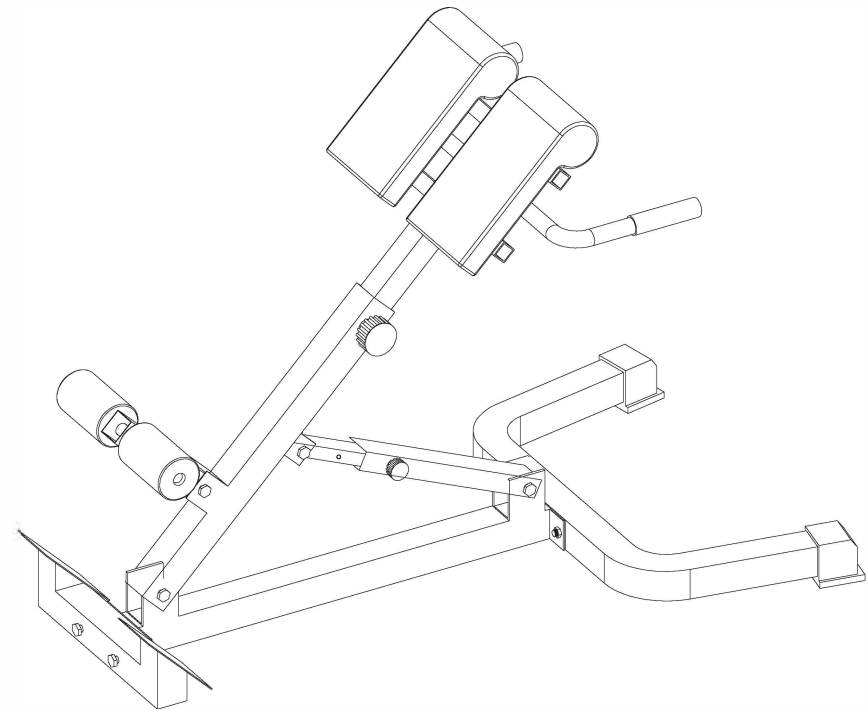

## Montageanleitung

# Teileliste

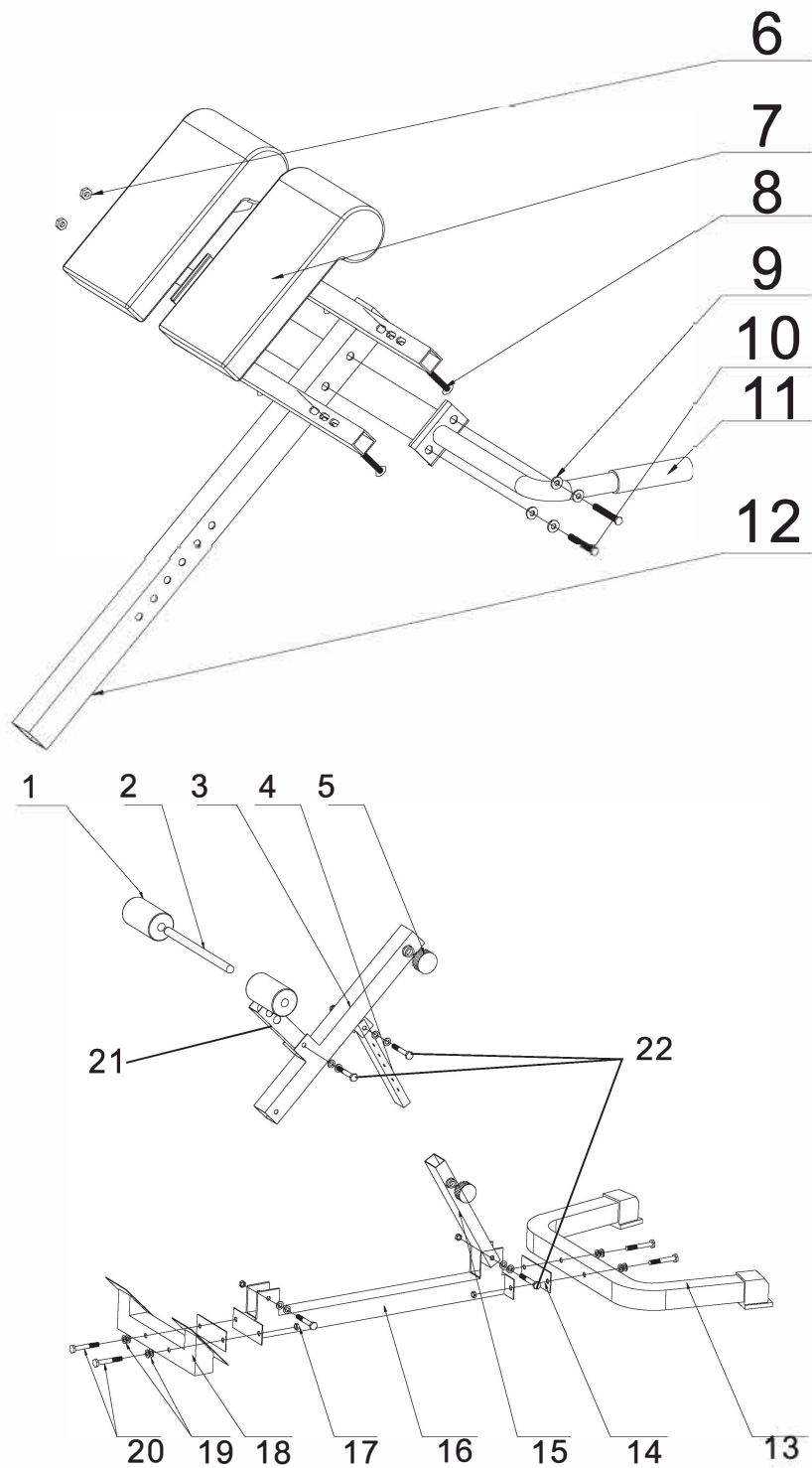

1: Schaumstoffpolster  
2 Stück



2: Polsterhalter  
2 Stück

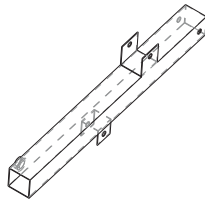

3: Hauptrahmenrohr 50mm  
1 Stück

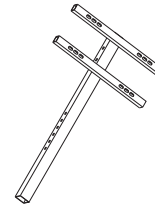

12: Verstellrohr  
1 Stück

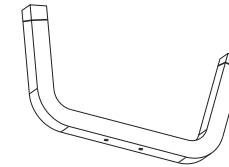

13: Vorderes unteres Rohr  
1 Stück

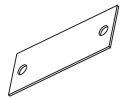

14: Stahlplatte  
2 Stück

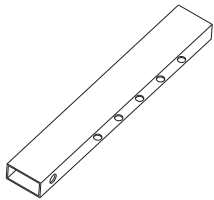

4: Stützrohr  
(inneres Rohr)-1 Stück



5: Federschraubverschluss  
2 Stück



6: M8 Mutter  
2 Stück

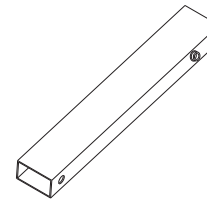

15: Stützrohr  
(äußeres Rohr)-1 Stück

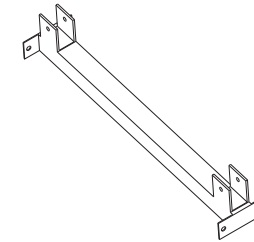

16: Hauptrahmen-Unterrohr  
1 Stück



17: M10 Mutter  
8 Stück

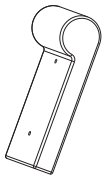

7: Polster  
2 Stück

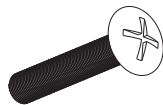

8: M8x40mm  
Senkkopfschraube-4 Stück



9: M8 Unterlegscheibe  
8 Stück

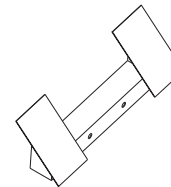

18: Hinteres unteres Rohr  
1 Stück



19: M10 Unterlegscheibe  
16 Stück



20: M10x70mm  
Sechskantschraube 5 Stück



10: M8x55mm Sechskantschraube-2 Stück

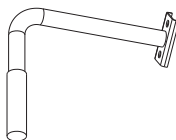

11: Linker Griff  
1 Stück

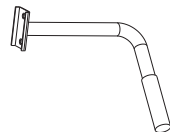

11: Rechter Griff  
1 Stück

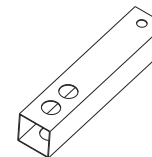

21: Fußpinch-Rohr  
1 Stück



22: M10x60mm  
Sechskantschraube-3 Stück